

PMU 充放電原理

Reported: 台北工程部

Date: Feb 21th 2017

Update : Apr 13th 2018



- PMU V.S Discrete Power IC
- CHG(CC & CV)
- OCV table
- Discharge curve

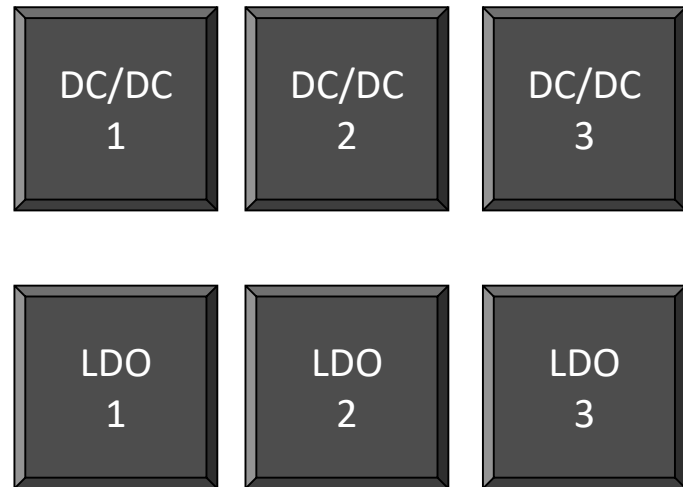
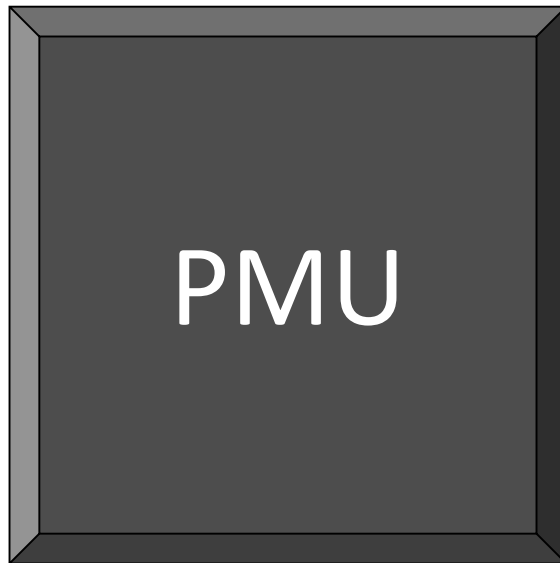

- Advantages :**
1. Saving SMT cost
 2. Saving Package cost
 3. Saving BOM space
 4. Easy control (DVS)
 5. Power on sequence



Charger One Chip Solution

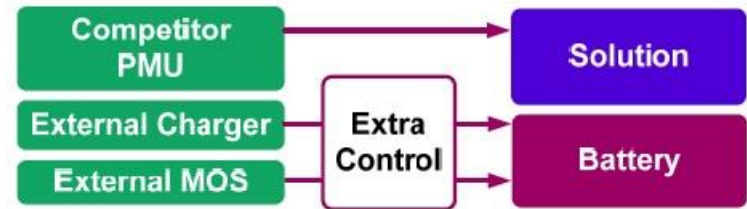
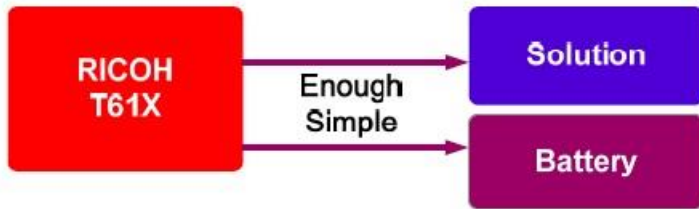

Charger Support Adapater and USB

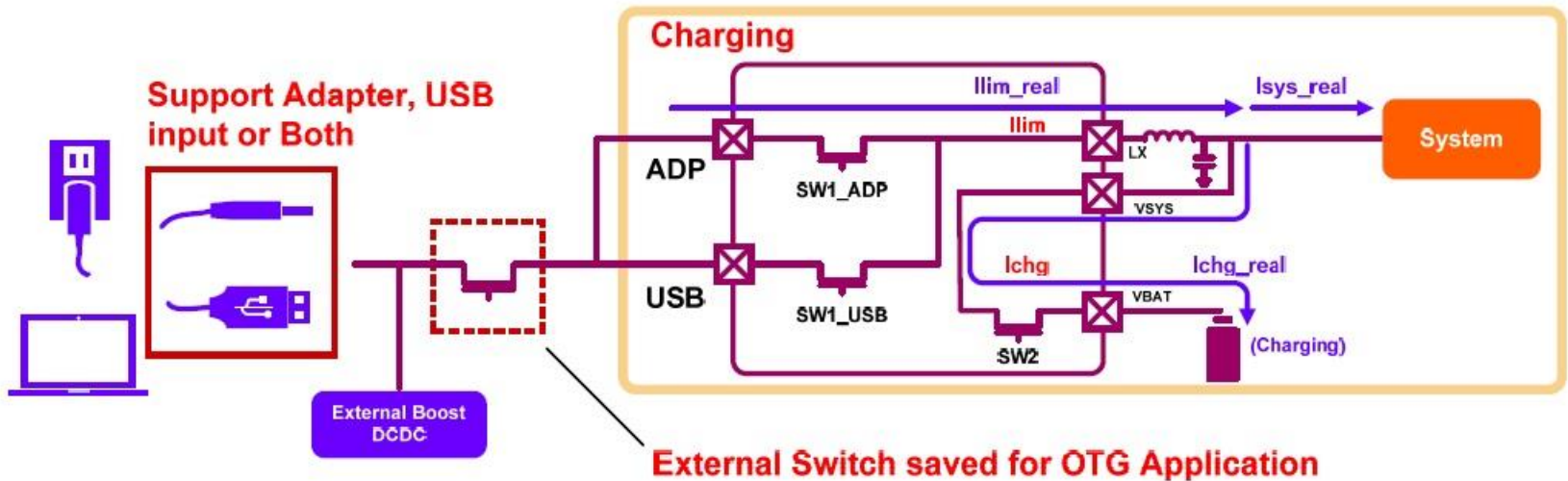



Charge Voltage / DSOC Chart

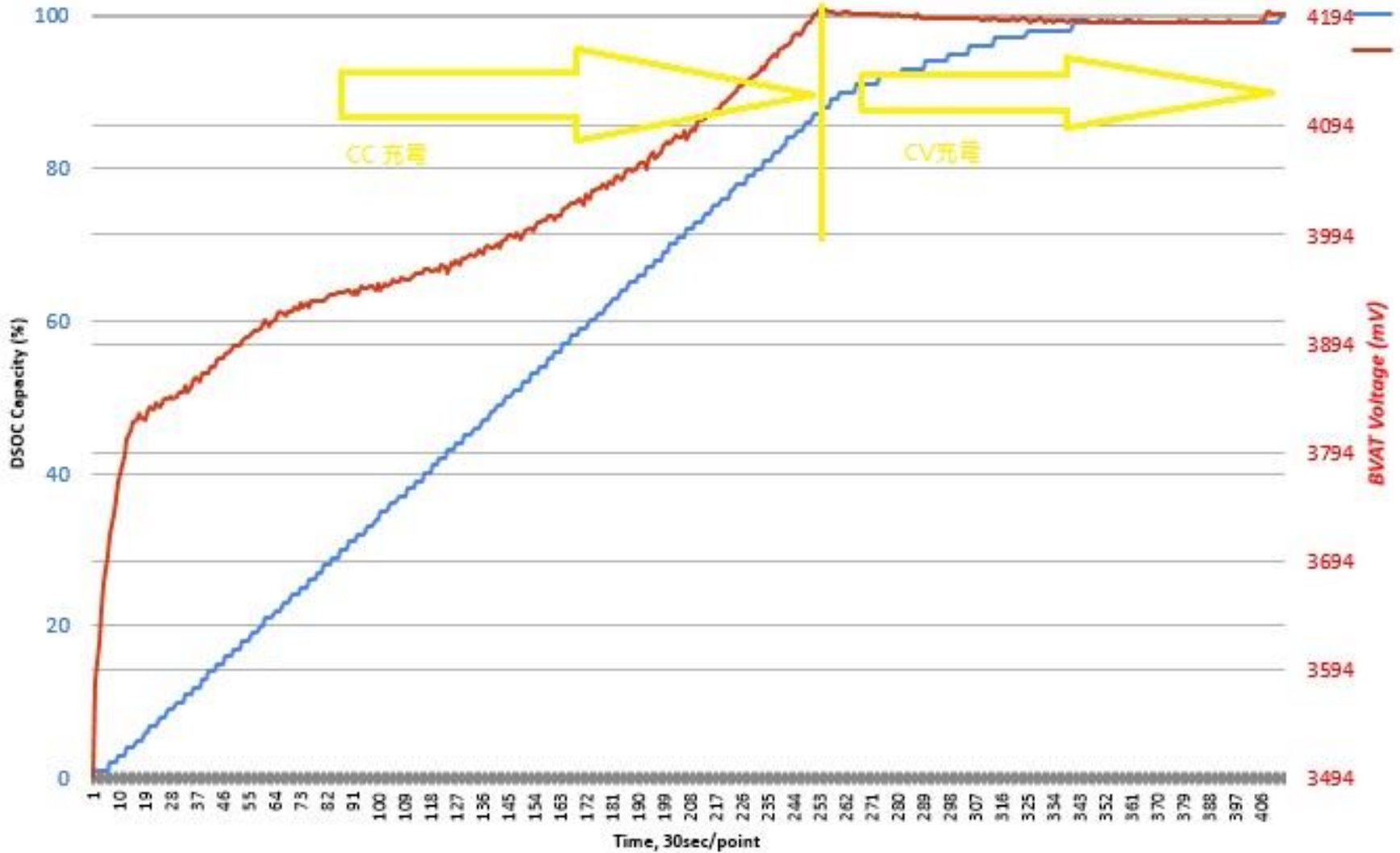



PMU 各功能概述(Fuel Gauge 電壓法)

AENEAS

Nominal Capacity mAh
Cut-off Voltage mV
Thermistor B Value
Board Impedance ohm

Load Current mA
Available Capacity mAh
Impedance ohm
Battery Voltage mV

OCV Table Making Complete.

OCV Table

SOC	Load-off V	OCV
100 %	4320	4320
90 %	4084	4209
80 %	3979	4106
70 %	3885	4018
60 %	3795	3947
50 %	3730	3858
40 %	3689	3818
30 %	3659	3794
20 %	3629	3757
10 %	3570	3700
0 %	2985	3259



Discharge log

AENEAS

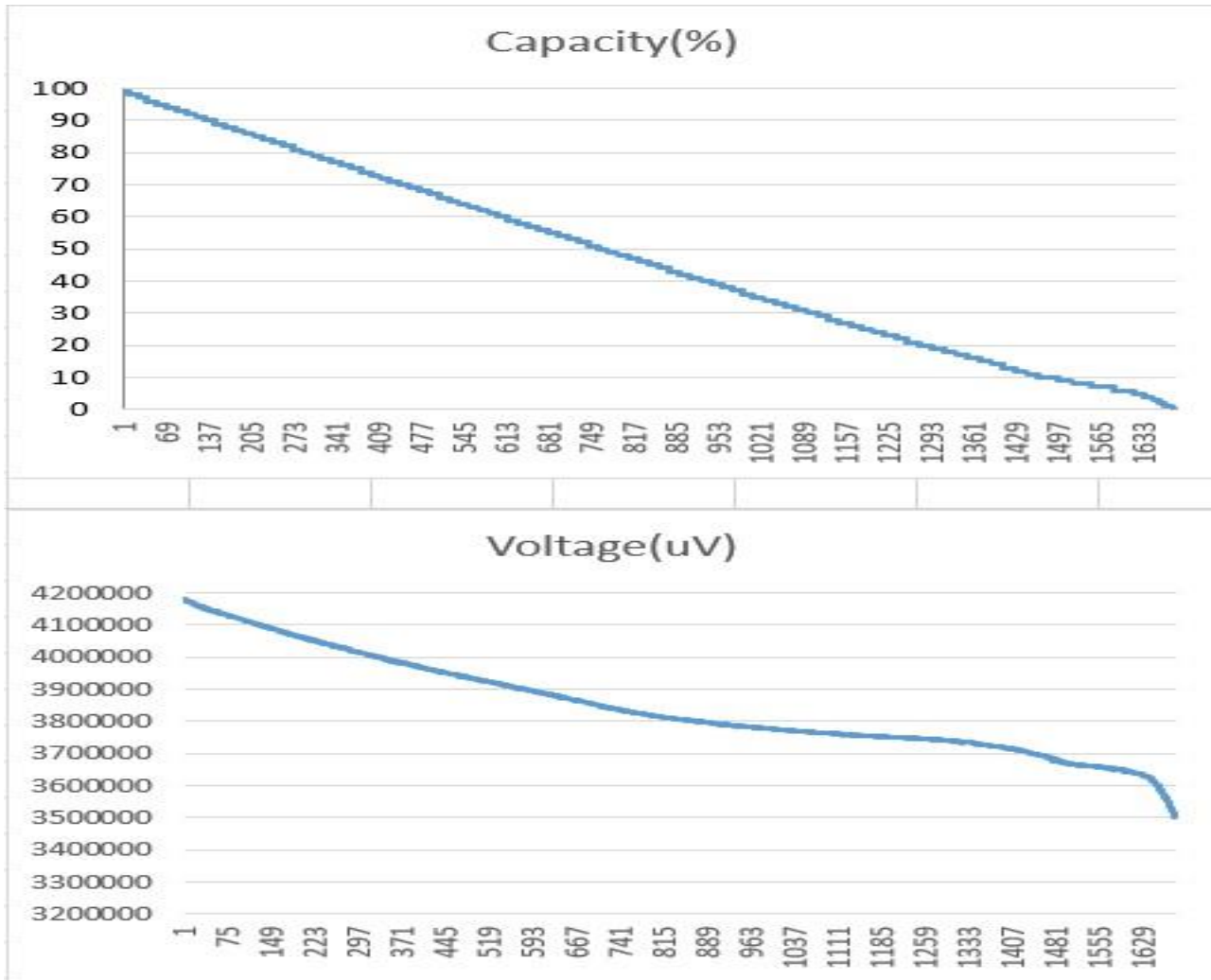



PMU 各功能概述(Power On 順序)

AENEAS

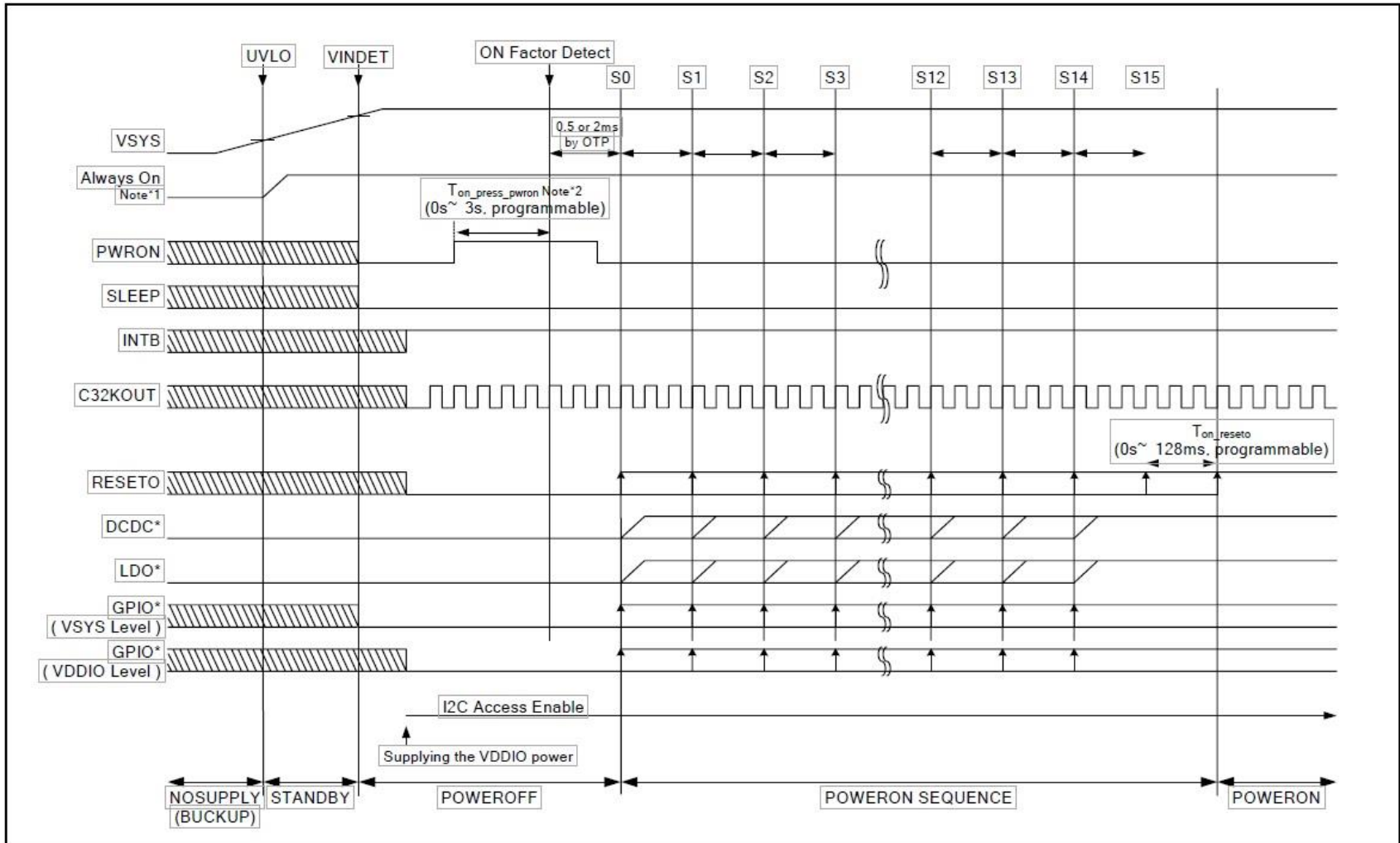



欲知詳情請洽...

AENEAS

FAE team

蕭翔文(Alvin)	alvin@aeneas.com.tw	(02)87974259#628
葉昇晏(Allen)	allen.ye@aeneas.com.tw	(02)87974259#635
許哲維(Leon)	leon@aeneas.com.tw	(02)87974259#636
王立文(Leo)	leo@aeneas.com.tw	(02)87974259#720
高士軒(Johnson)	johnson@aeneas.com.tw	(02)87984259#637
林佳慧(Amber)	amber@aeneas.com.tw	(02)87974259#629



Thank You

AENEAS

