

PMU 介紹

Reported: 台北工程部

Date: Feb 21th 2017

Update :





- 什麼是 PMU ?
- PMU 基本架構
- PMU 各功能概述
- Ricoh PMU Introduce .



什麼是 PMU ?

AENEAS

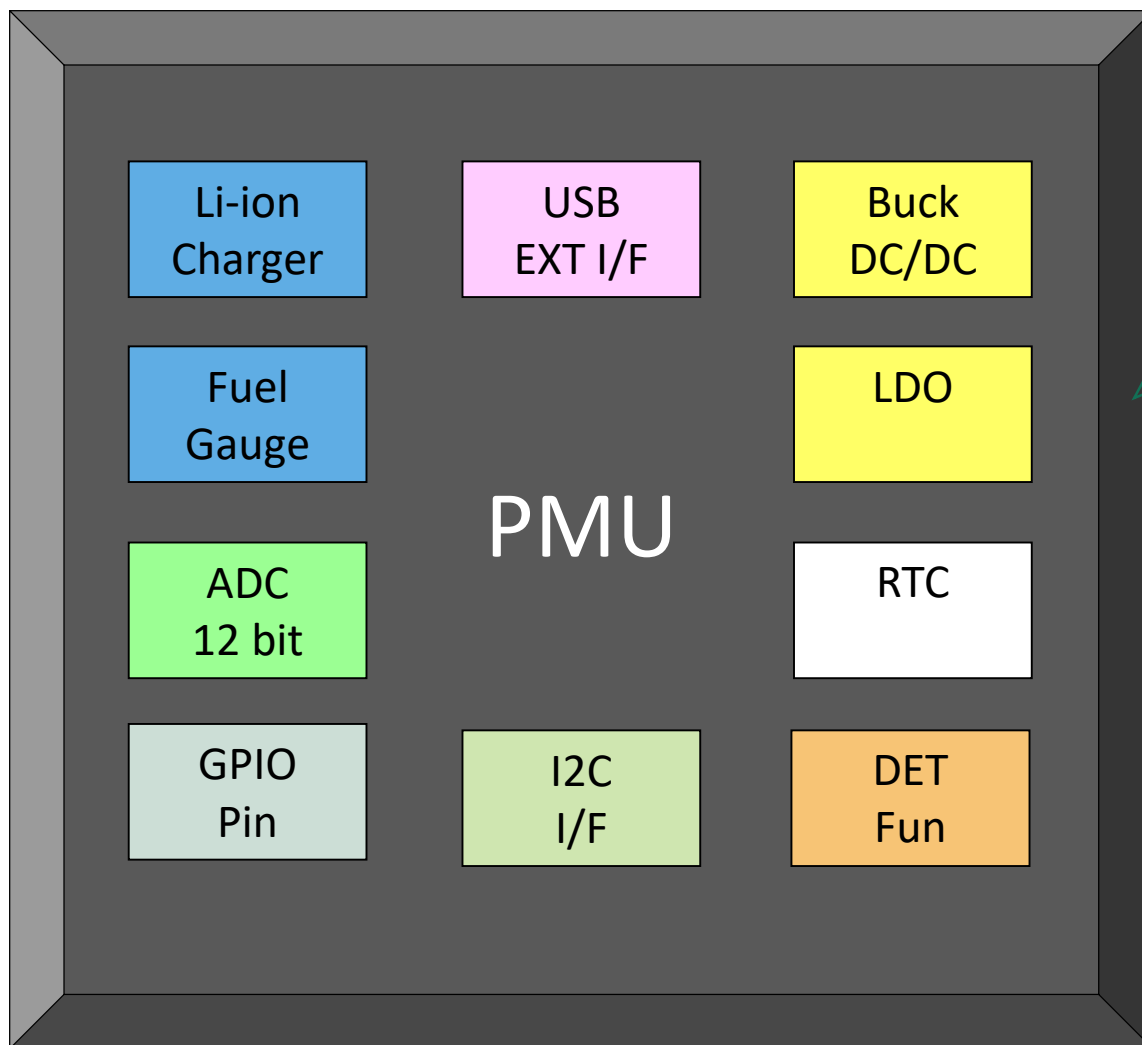

- **PMU**
(Power Management Unit)
- **Multi-PMU**
- **PMIC**
(Power Management IC)
- 多通道電源管理IC
- 電源管理IC

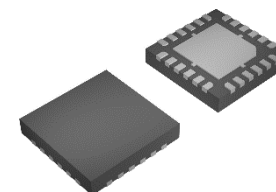



PMU 基本架構

AENEAS

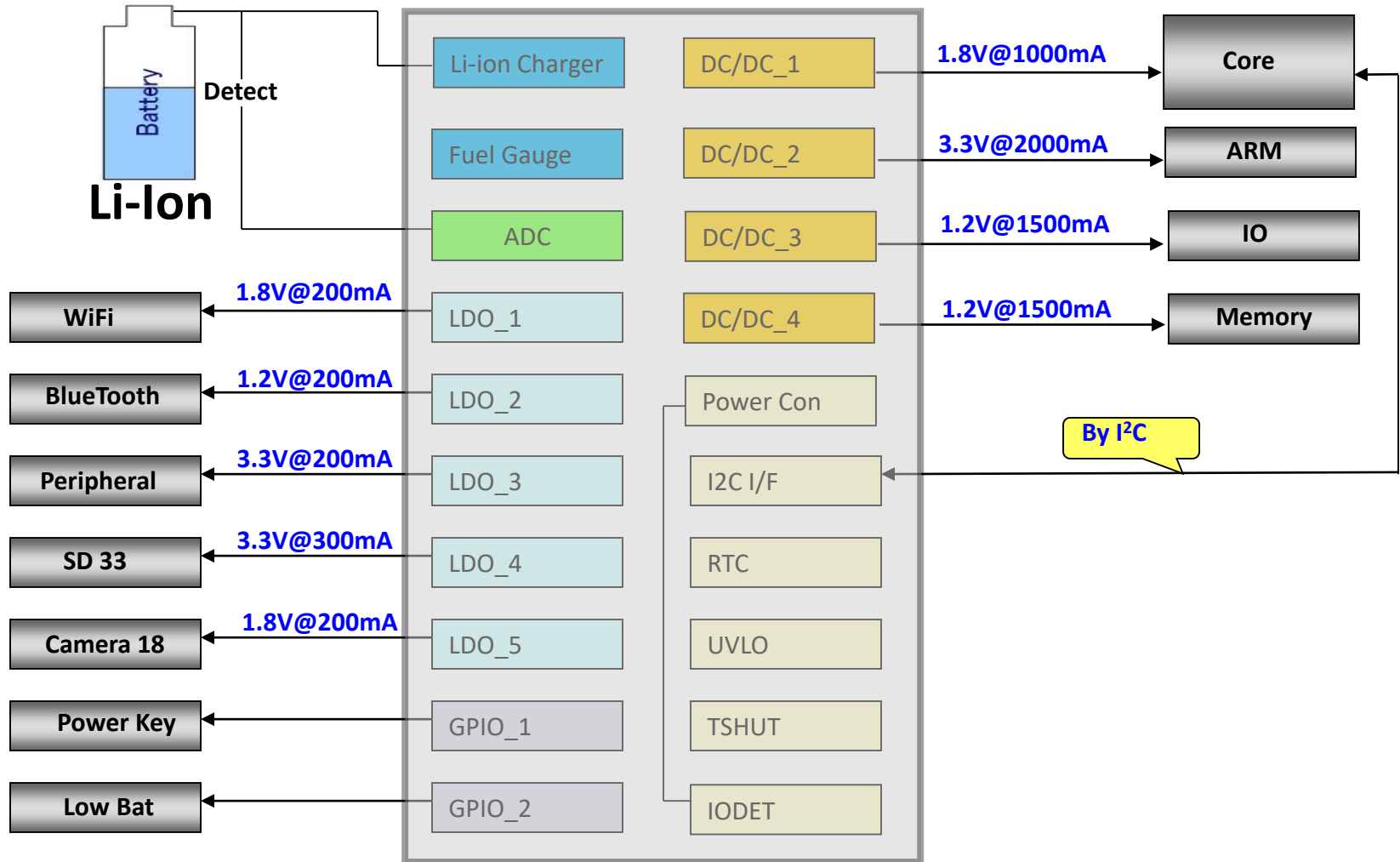



Charger One Chip Solution

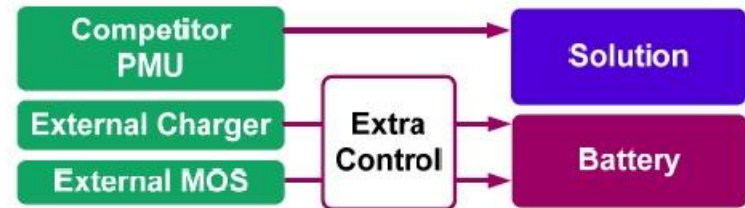
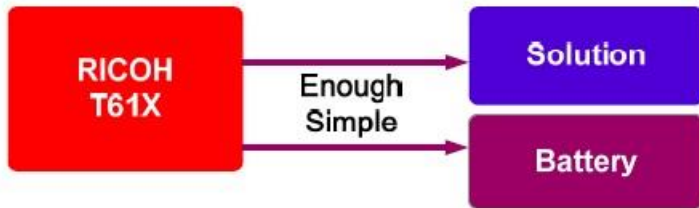

Charger Support Adapter and USB

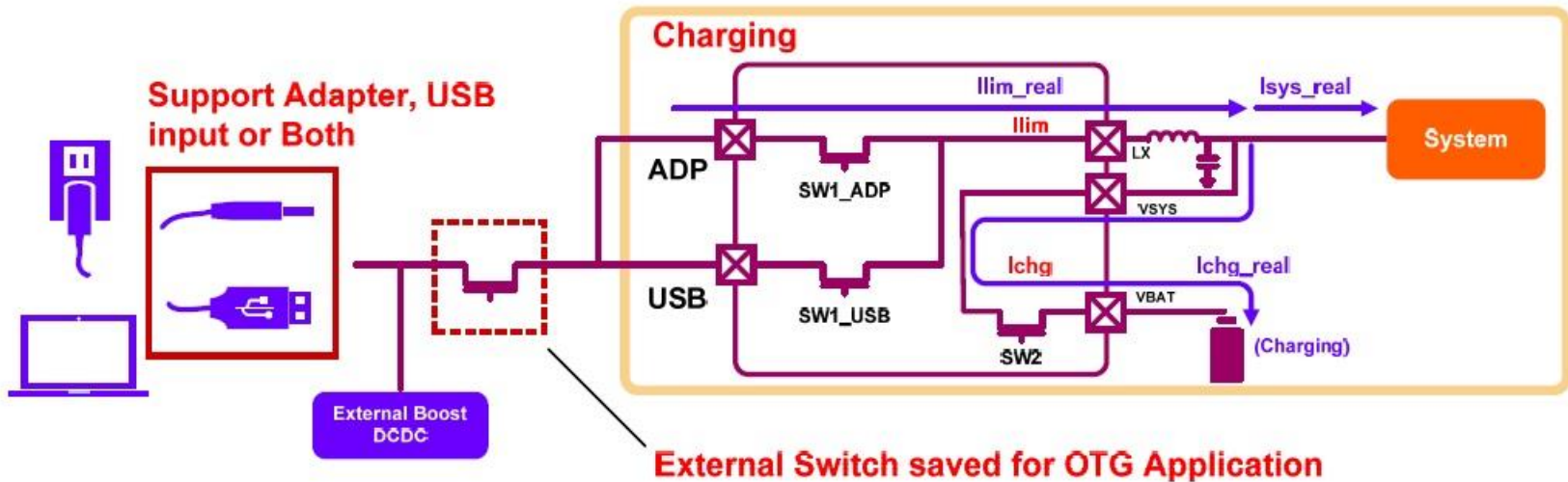



PMU 各功能概述(Fuel Gauge 電壓法)

AENEAS

Nominal Capacity mAh
Cut-off Voltage mV
Thermistor B Value
Board Impedance ohm

Load Current mA
Available Capacity mAh
Impedance ohm
Battery Voltage mV

OCV Table Making Complete.

OCV Table

SOC	Load-off V	OCV
100 %	4320	4320
90 %	4084	4209
80 %	3979	4106
70 %	3885	4018
60 %	3795	3947
50 %	3730	3858
40 %	3689	3818
30 %	3659	3794
20 %	3629	3757
10 %	3570	3700
0 %	2985	3259



PMU 各功能概述(Fuel Gauge 電流法)

AENEAS

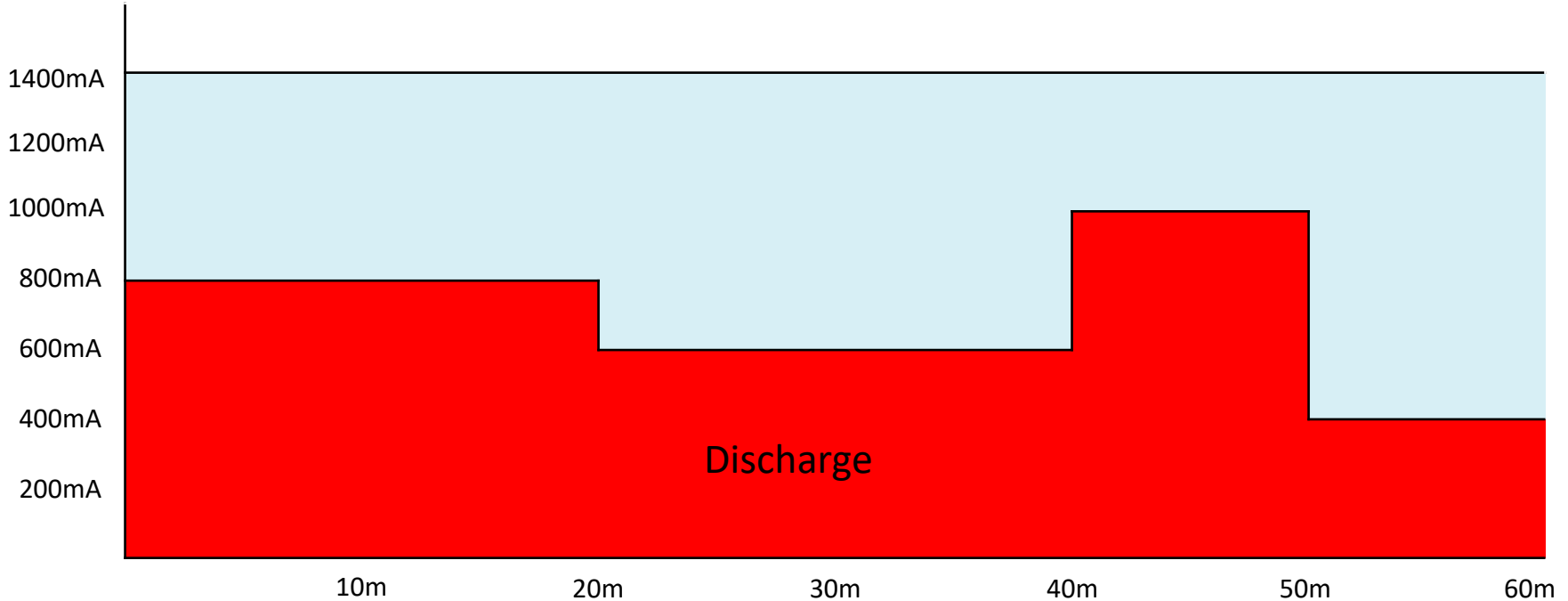

Coulomb counter 原理:







透過電流與時間的積分，來計算電池的剩餘電量，精確度較高。

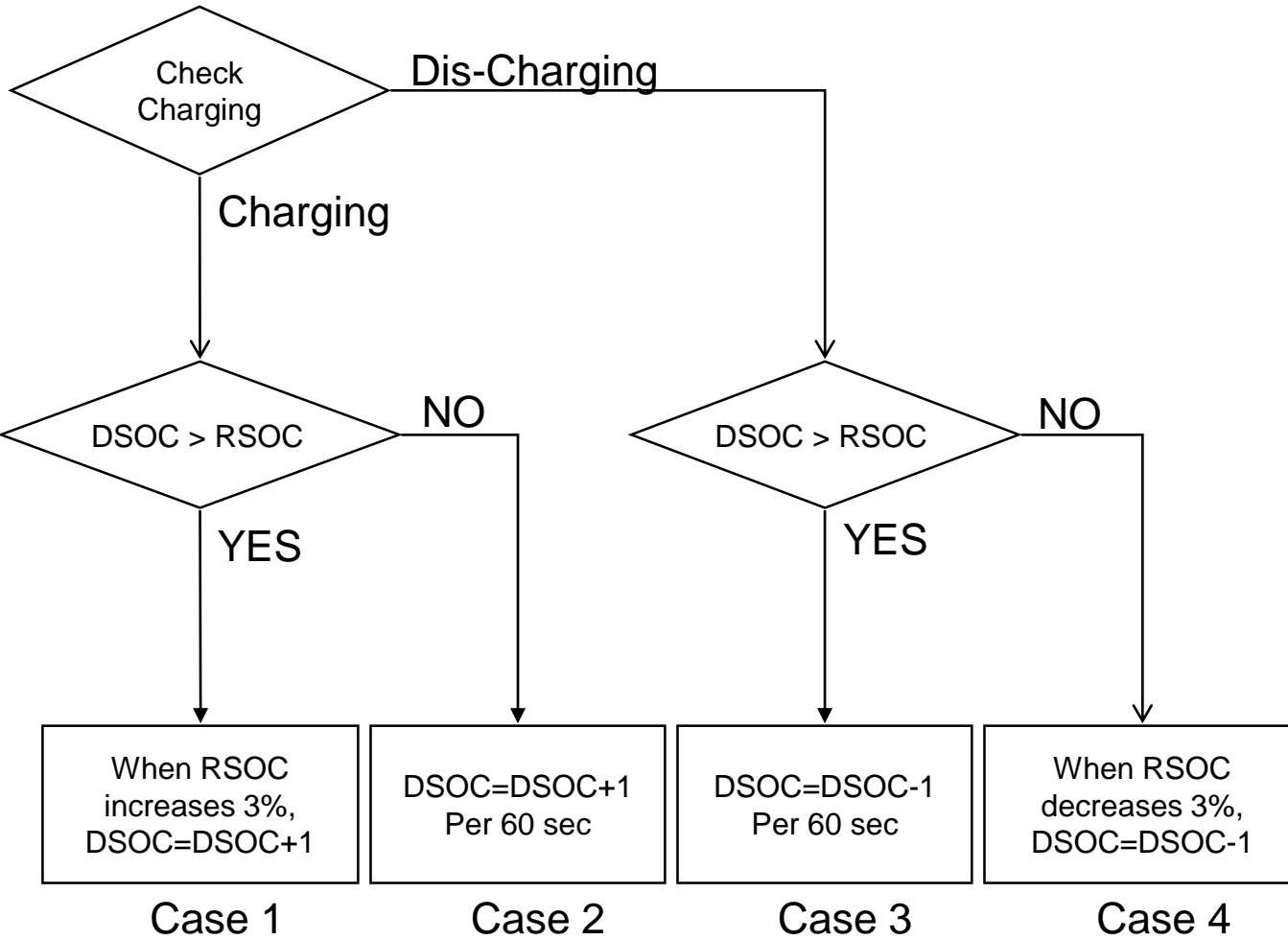

Smoothing Function

AENEAS



Charging	Dis-Charging
Case 1 DSOC  1% RSOC  3%	Case 3 DSOC 60 sec  1%
Case 2 DSOC  1% 60 sec	Case 4 DSOC  1% RSOC  3%



欲知詳情請洽...

AENEAS

FAE team

蕭翔文(Alvin)	alvin@aeneas.com.tw	(02)87974259#628
葉昇晏(Allen)	allen.ye@aeneas.com.tw	(02)87974259#635
許哲維(Leon)	leon@aeneas.com.tw	(02)87974259#636
王立文(Leo)	leo@aeneas.com.tw	(02)87974259#720
李柏翰(Jesper)	jesper@aeneas.com.tw	(02)87974259#639

Ricoh Power IC 官網資訊:

http://www.e-devices.ricoh.co.jp/en/products/product_power/



Thank You

AENEAS

